

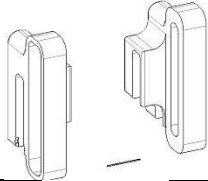





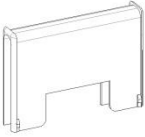

## NOTICE DE MONTAGE

### **DEFLECTEUR UNIVERSEL ERMAX « CLIP & FLIP »**

Durée estimée de montage : 10min

	1	Glissière
	2	Fixation bulle
	3	Caoutchouc
	4	Vis CHC 6x30
	5	x2 Vis sans tête M6
	6	x2 Vis sans tête M3
	7	Erou
		Clef BTR 3
		Clef BTR 2

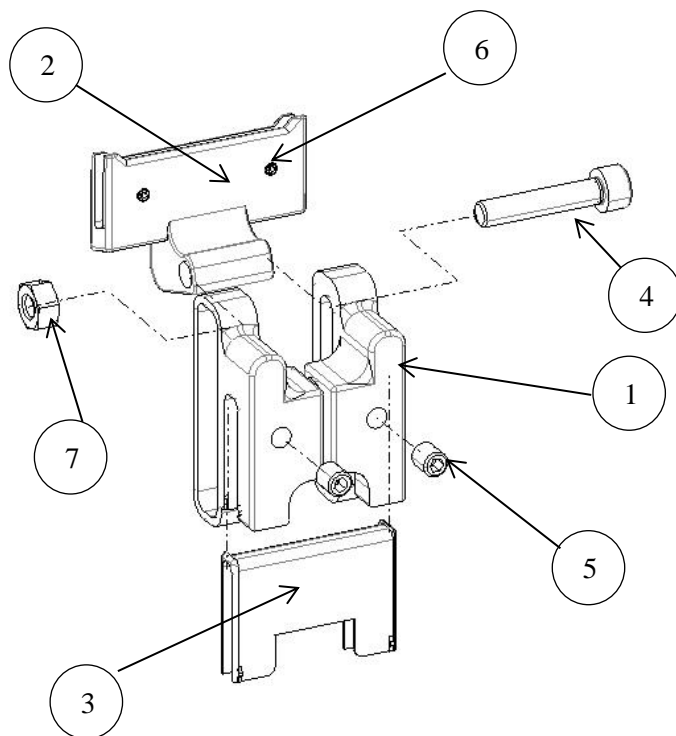

### Montage

- Assembler les pièces glissière (1) et fixation bulle (2) grâce à la vis CHC 6x30 (4) et l'écrou (7).
- Insérer le caoutchouc (3) dans la glissière (1).
- Mettre en place les vis sans tête M6 (5) dans la glissière (1).
- Mettre en place les vis sans tête M3 (6) dans la fixation bulle (2).
- Insérer la bulle du kit Clip & Flip dans la fixation bulle (2) puis serrer.

#### « ATTENTION »

\* Tout accessoire monté ne sera plus considéré comme neuf et ne sera **ni repris ni échangé**.

\* Les marques de fabricant de motos citées sont indiquées exclusivement comme référence nécessaire à la destination des accessoires Ermax.







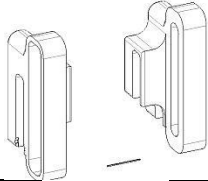

\* Attention aux serrages excessifs qui pourraient abîmer ou casser nos accessoires en plastique et les vis en aluminium.

\* Les bulles abîmées par un **lavage inadéquat** ne sont pas garanties (dissolvant, essence, détergent, produits abrasifs, corrosifs...). Essuyer immédiatement les liquides de frein ou de batterie qui pourraient déborder sur les accessoires.

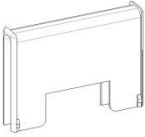
## FITTING INSTRUCTIONS

### ERMAX UNIVERSAL DEFLECTOR « CLIP & FLIP »

Estimated mounting time : 10min

	1	Sliding guide
	2	Screen fixation
	3	Rubber
	4	Screw CHC 6x30
	5	x2 Headless screw M6
	6	x2 Headless screw M3
	7	Nut
		Hex key BTR 3
		Hex key BTR 2

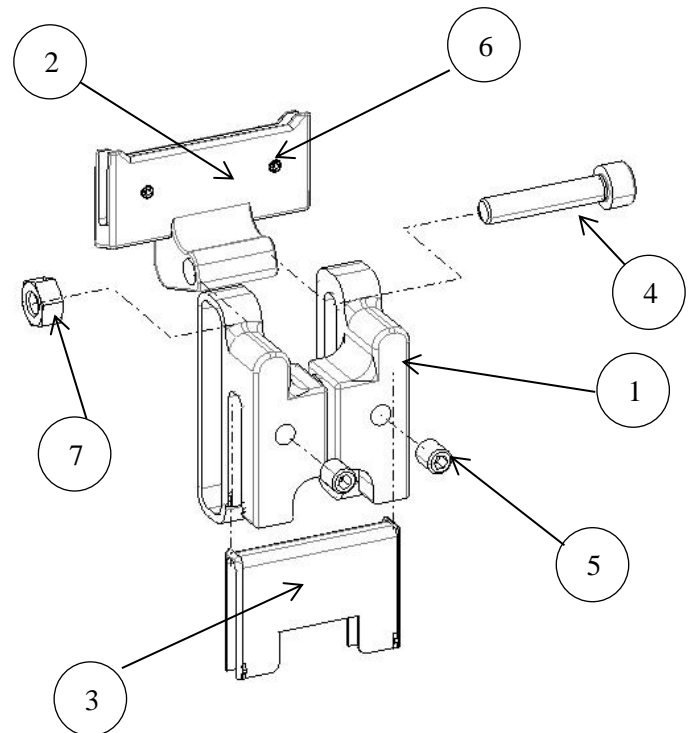

### Fitting instructions

- Assemble the sliding guide (1) and screen fixation (2) thanks to the screw CHC 6x30 (4) and the nut (7).
- Insert the rubber (3) in the sliding guide (1).
- Place the headless screws M6 (5) in the sliding guide (1).
- Place the headless screws M3 (6) in the screen fixation (2).
- Insert the Clip & Flip screen in the screen fixation (2) and then tighten.

#### « CAUTION »

\* Accessories gone up on the motorbike will not be any more considered as new and will be **neither retaken nor exchanged**.

\* The mentioned label of motorbikes's manufacturers are indicated exclusively as a reference to Ermax accessories.

\* Care to excessive clampings which may damage or break our plastic accessories and aluminium screws.

\* Screens damaged by an **inadequat washing** are not guaranteed (abrasive, corrosive ... products, solvent, thinner, benzine ...). Wash immediately brake or battery fluid which may flow on accessories.